

Improving Time Accuracy of Servers Across the Facebook Fleet

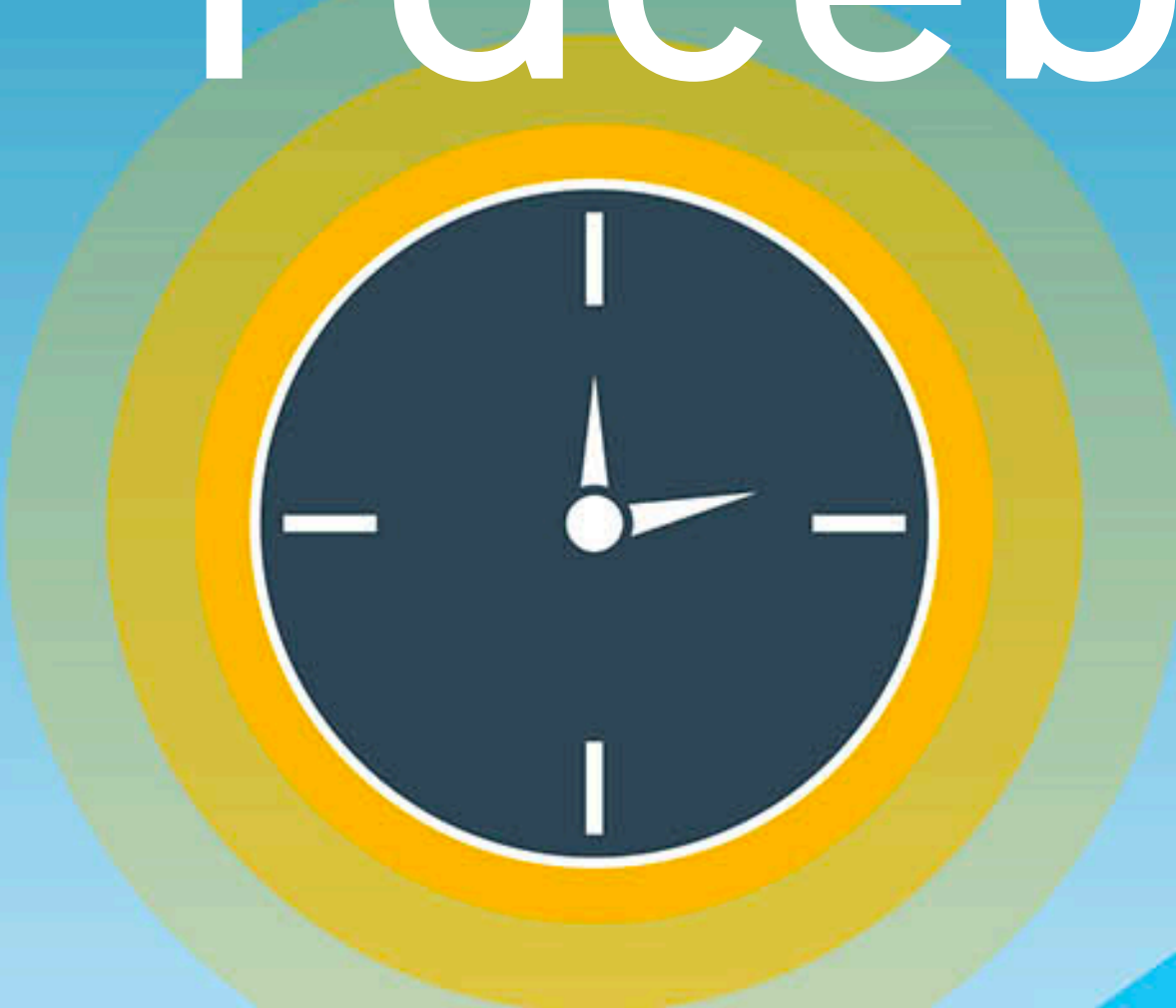

Oleg Obleukhov
Production engineer

FACEBOOK



Typical NTP hierarchy

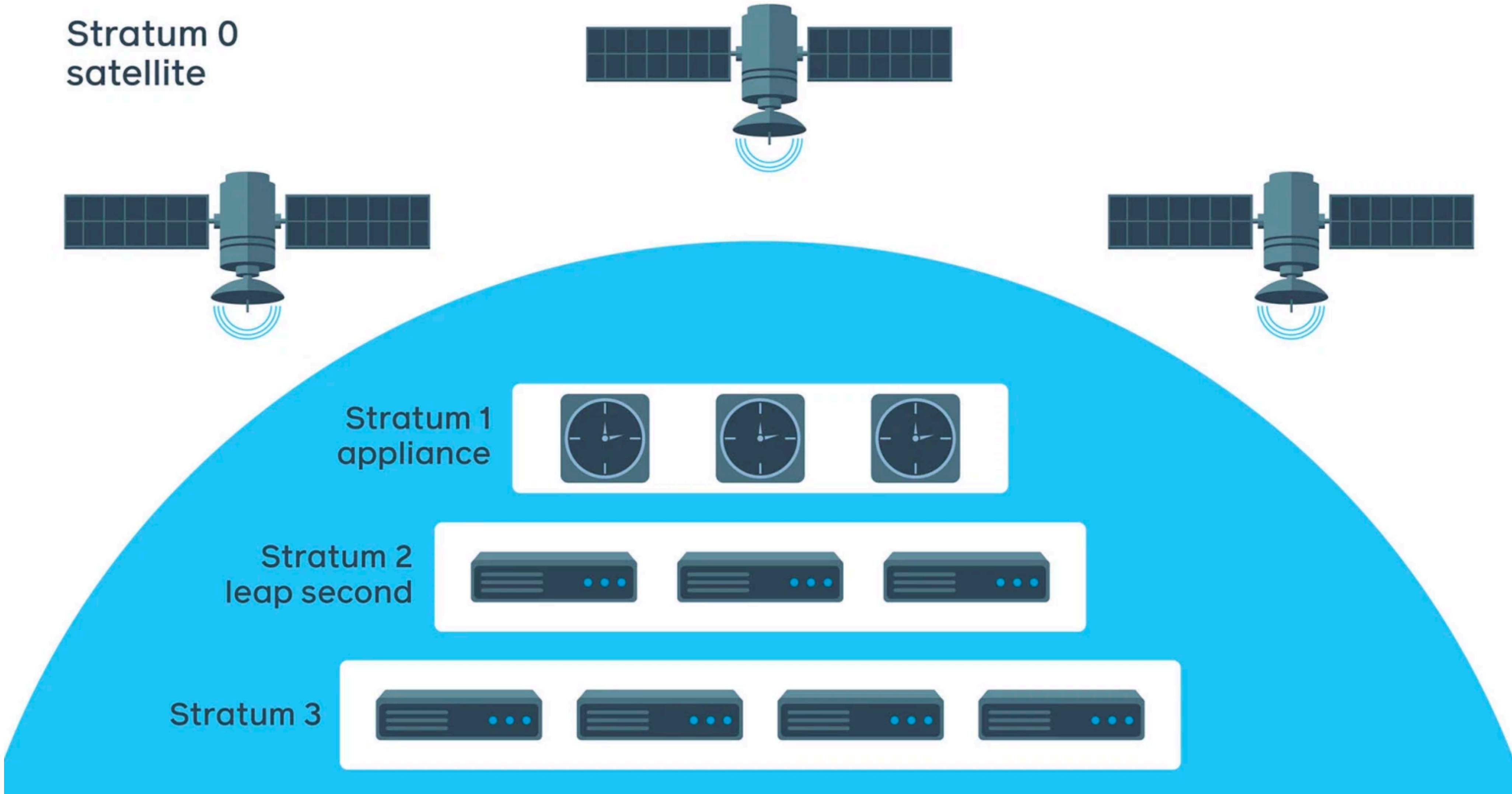

Once upon a time

```
1 [user@client ~]# ntpq -p
2 remote          refid          st t when poll reach  delay  offset  jitter
3 =====
4 +server1         .FB.           2 u  406 1024  377  0.029  0.149  0.035
5 +server2         .FB.           2 u  548 1024  377  0.078  0.035  0.083
6 *server3         .FB.           2 u  460 1024  377  0.049 -0.185  0.114
```

Improving precision

Improving precision

```
1 [user@client ~]# chronyc sources -v
2 210 Number of sources = 19
3   .-- Source mode  '^' = server, '=' = peer, '#' = local clock.
4   /  .- Source state '*' = current synced, '+' = combined , '-' = not combined,
5   | /   '?' = unreachable, 'x' = time may be in error, '~' = time too variable.
6   ||
7   ||           Reachability register (octal) -.
8   ||           Log2(Polling interval) --.
9   ||
10  ||           \
11  ||           |
12  ||           |
13  ||           \
14  ||           |
15  ||           |
16  ||           \

MS Name/IP address          Stratum Poll Reach LastRx Last sample
=====
^+ server1                  2    6  377     2   +10us[ +10us] +/-  481us
^- server2                  2    6  377     0  -4804us[-4804us] +/-   77ms
^* server3                  2    6  377    59   -42us[ -46us] +/-  312us
^+ server4                  3    6  377    60   +11ns[-3913ns] +/-  193us
```



Improving precision

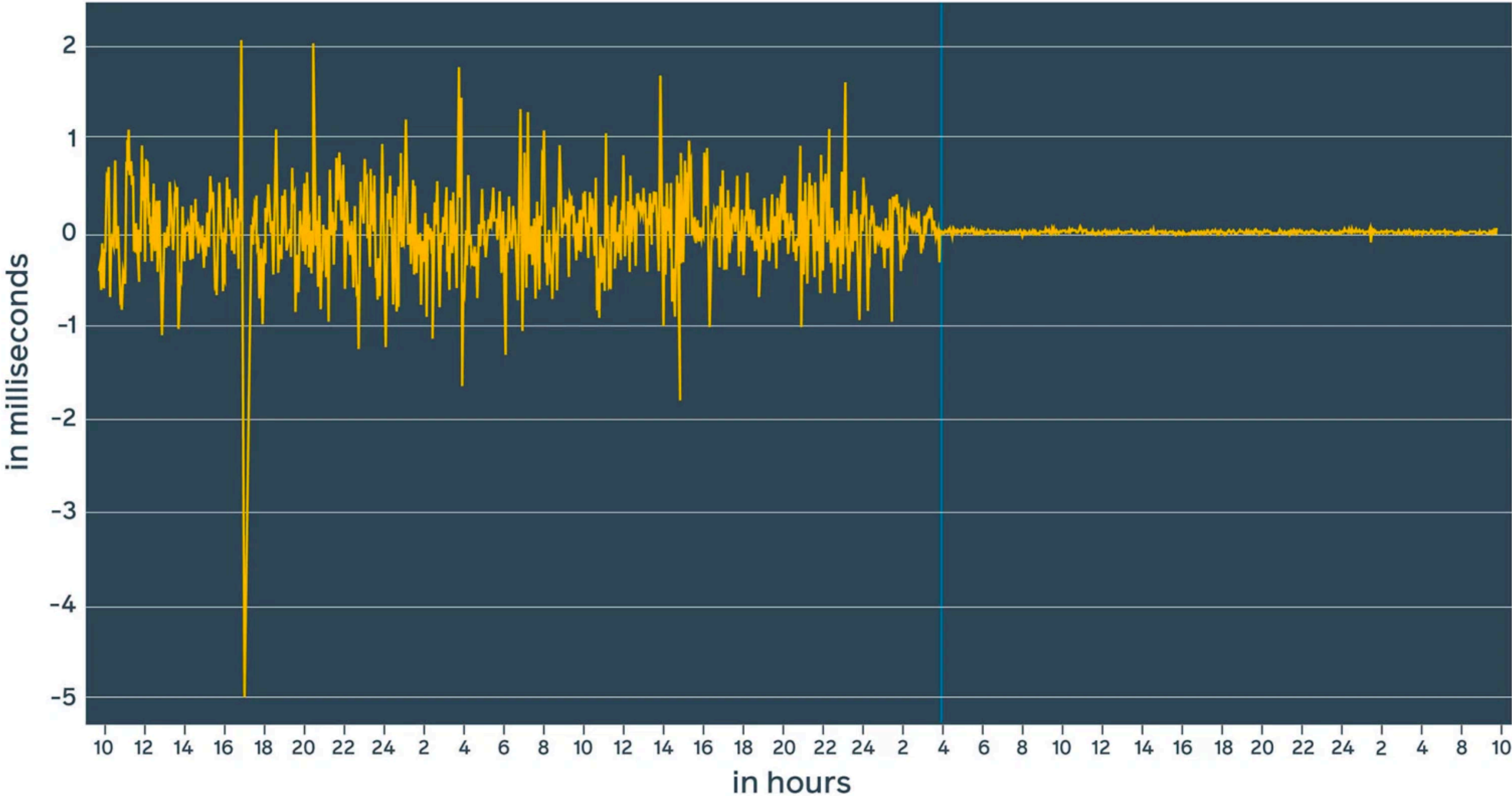

Validating improvements

Validating improvements. 1PPS

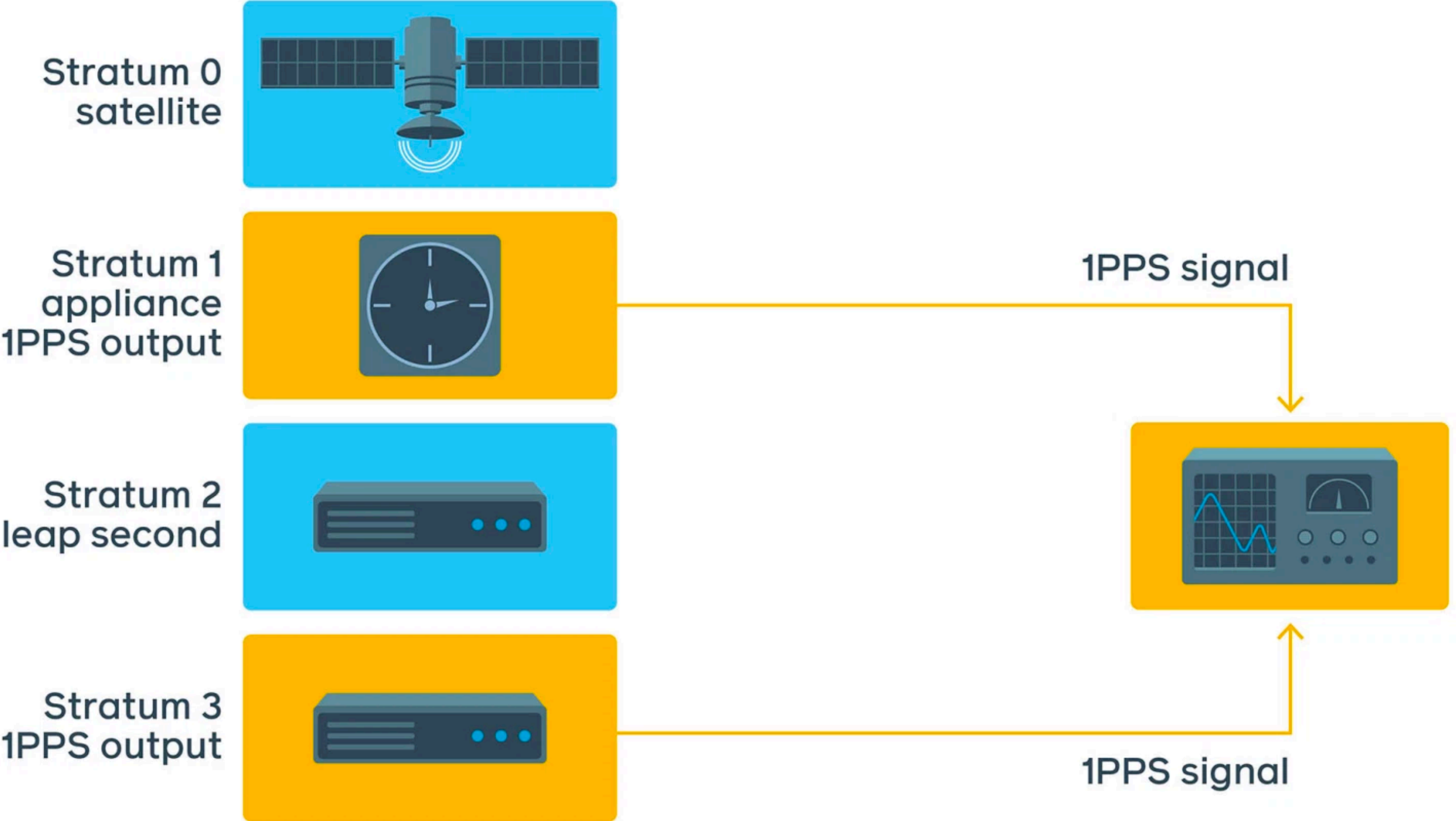

Validating improvements. 1PPS

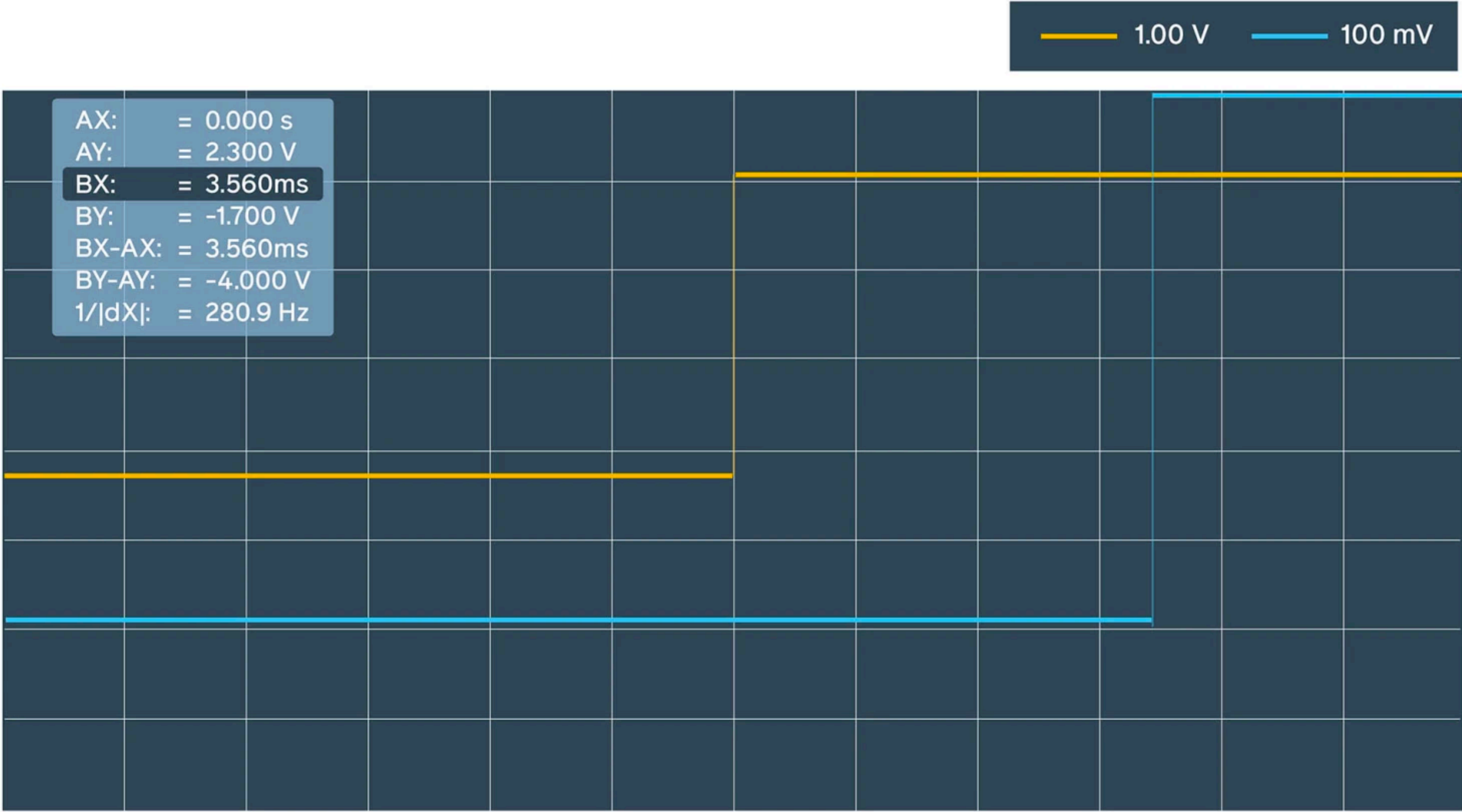

Validating improvements. Dedicated testing device

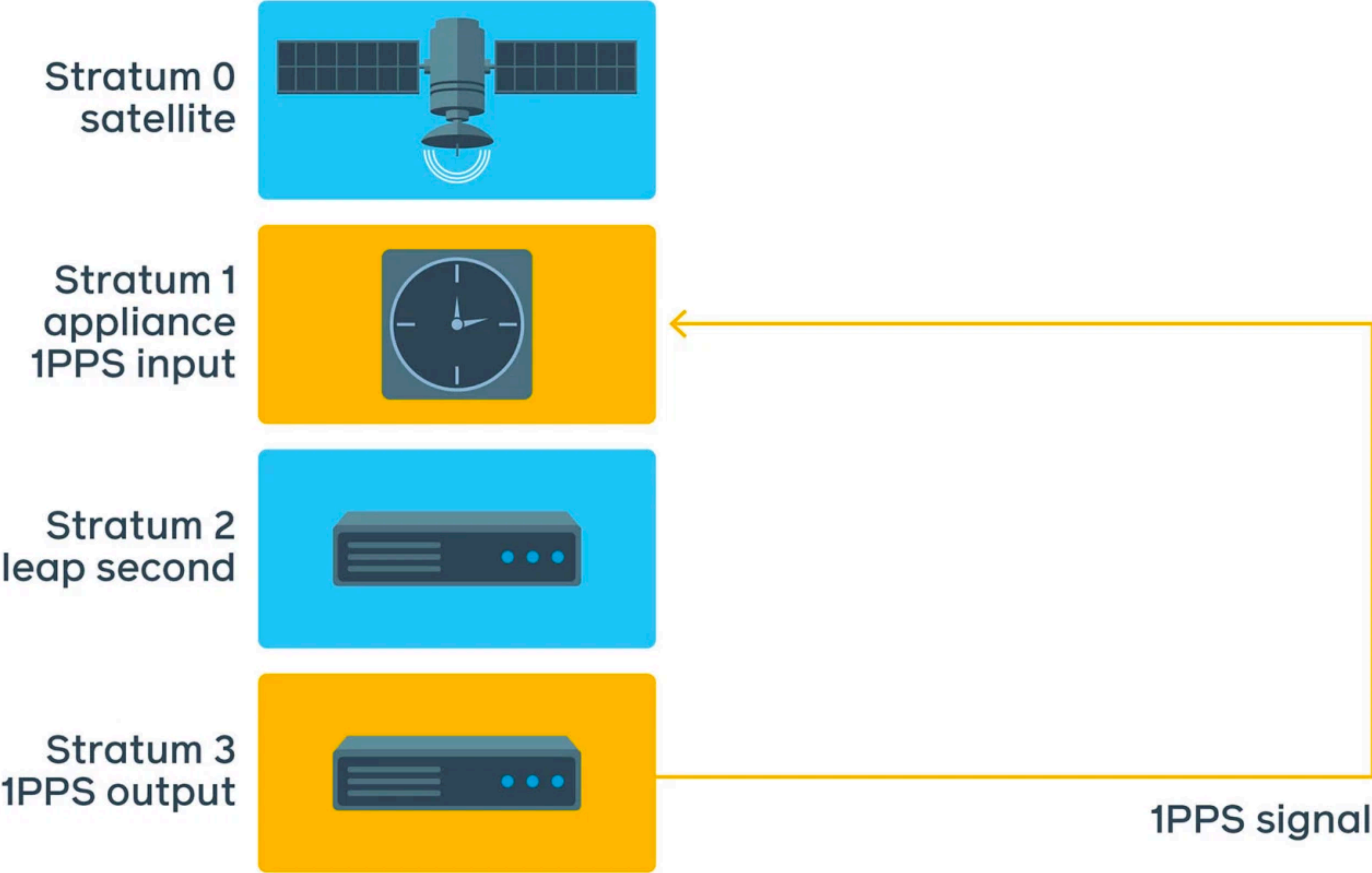

Validating improvements. Dedicated testing device

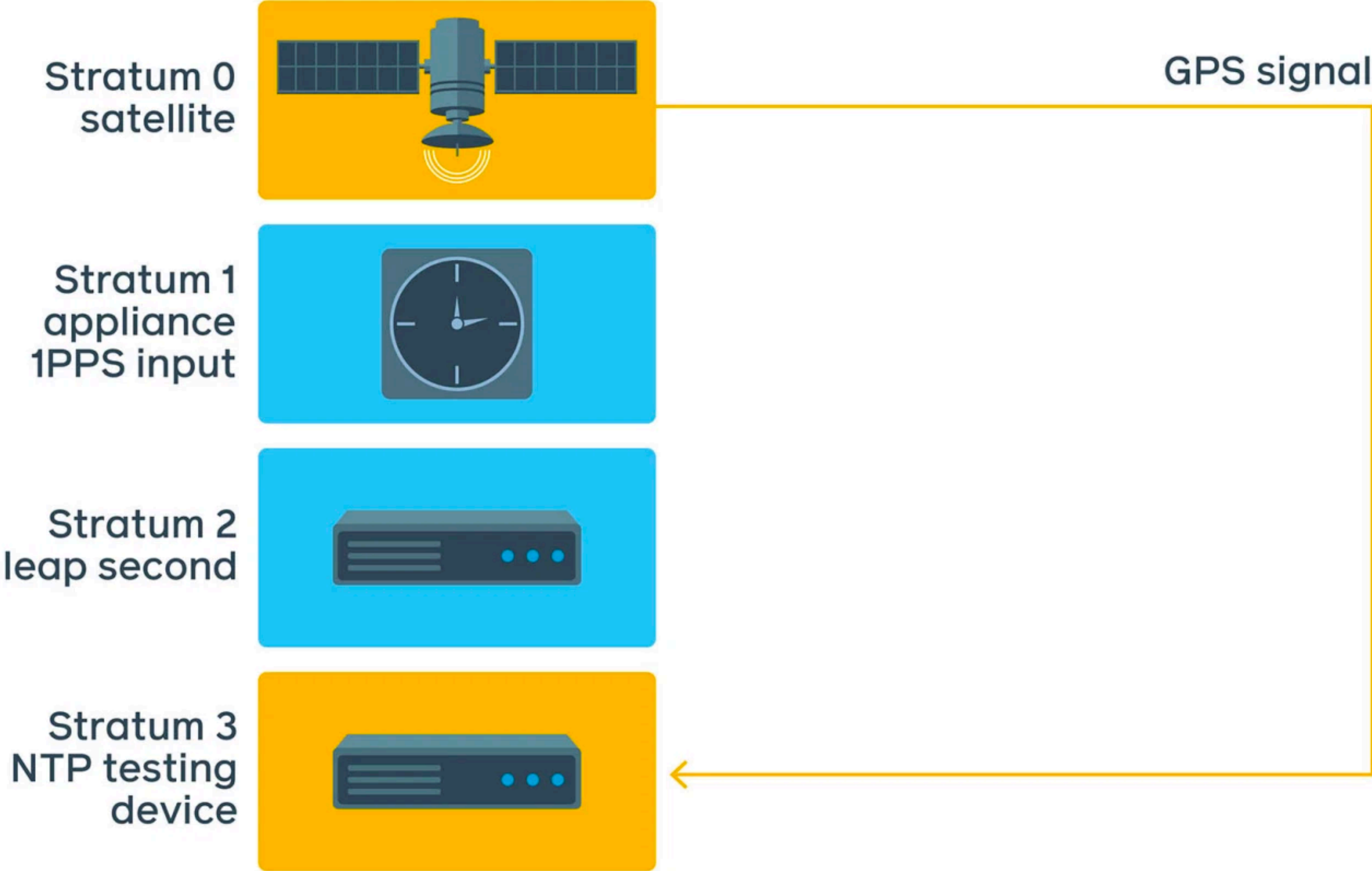

Validating improvements. Dedicated testing device

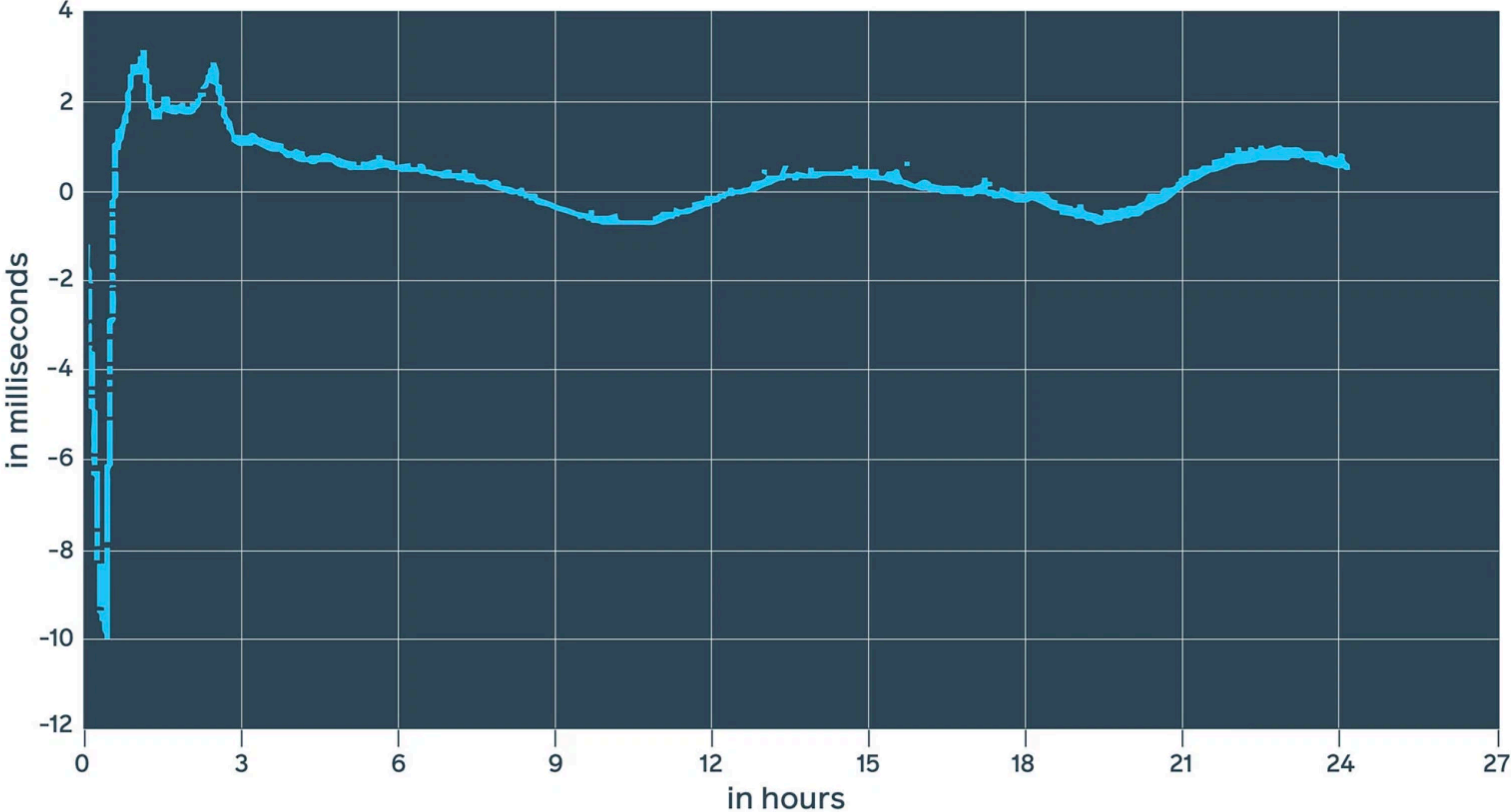

Validating improvements. Dedicated testing device

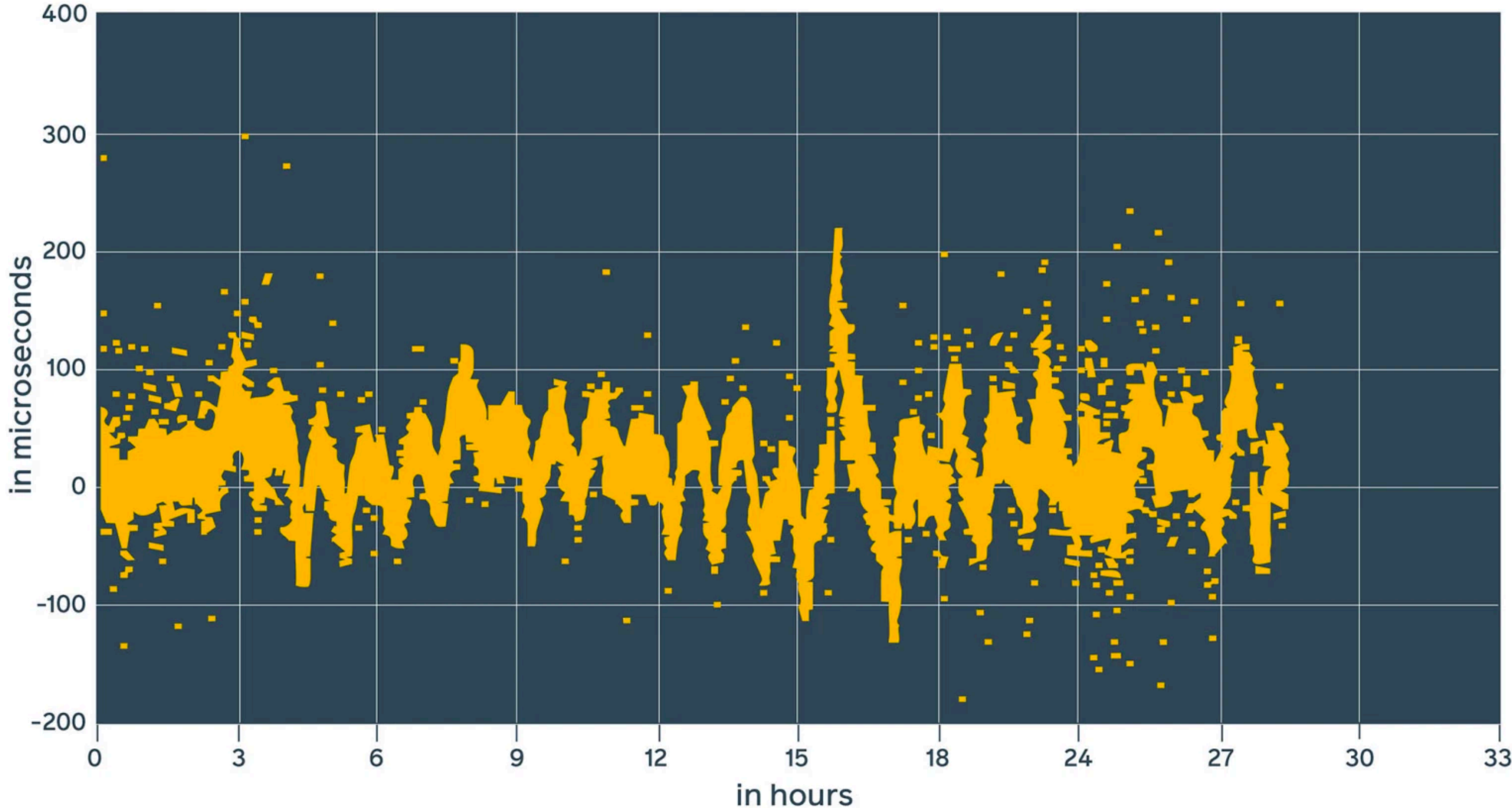

Improving precision

```
1 [user@client ~]# chronyc sources -v
2 210 Number of sources = 19
3   .-- Source mode  '^' = server, '=' = peer, '#' = local clock.
4   /  .- Source state '*' = current synced, '+' = combined , '-' = not combined,
5   | /  '?' = unreachable, 'x' = time may be in error, '~' = time too variable.
6   ||
7   ||           Reachability register (octal) -.
8   ||           Log2(Polling interval) --.
9   ||           \
10  ||           |
11  ||           |
12  ||           \
13  ||           |
14  ||           |
15  ||           |
16  ||           \

MS Name/IP address           Stratum Poll Reach LastRx Last sample
=====
^+ server1                   2    6  377    2   +10us[ +10us] +/-  481us
^+ server2                   2    6  377    0  -4804us[-4804us] +/-   77ms
^* server3                   2    6  377   59   -42us[ -46us] +/-  312us
^+ server4                   3    6  377   60   +11ns[-3913ns] +/-  193us
```



Validating improvements. Timestamps

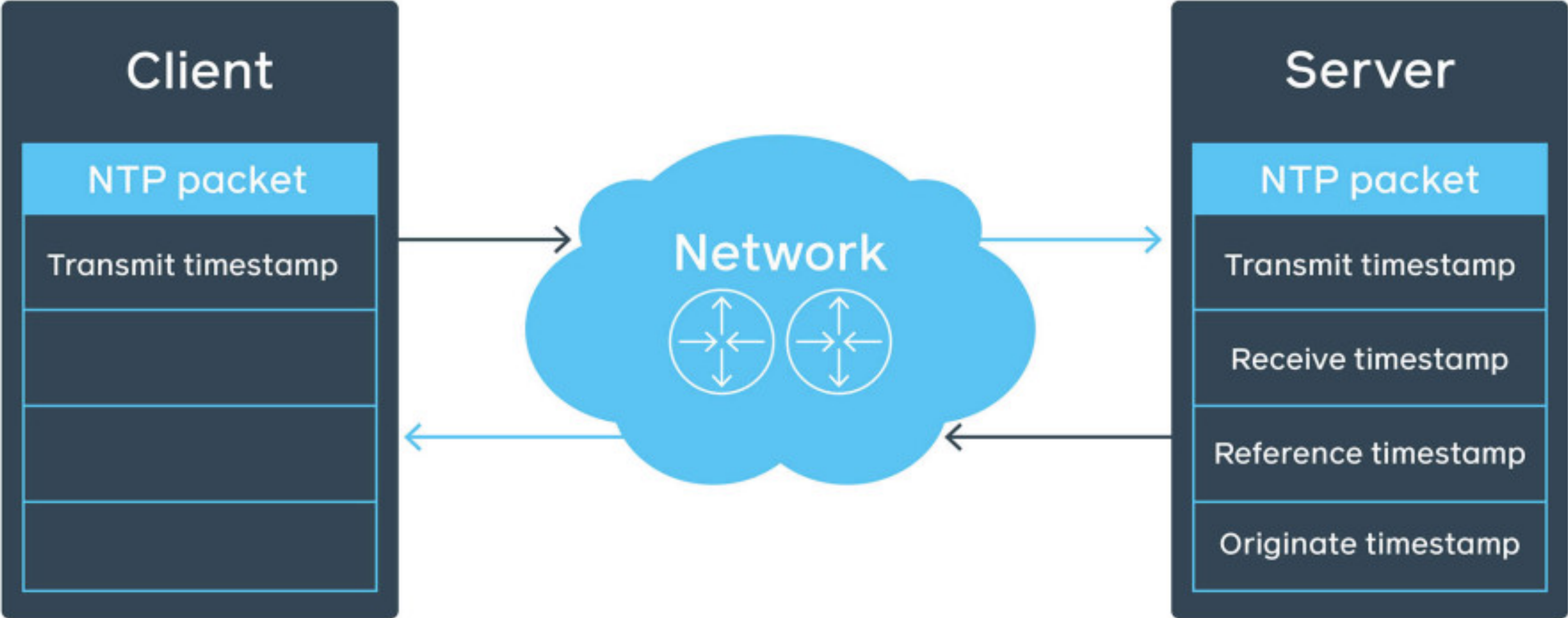

Validating improvements. Timestamps

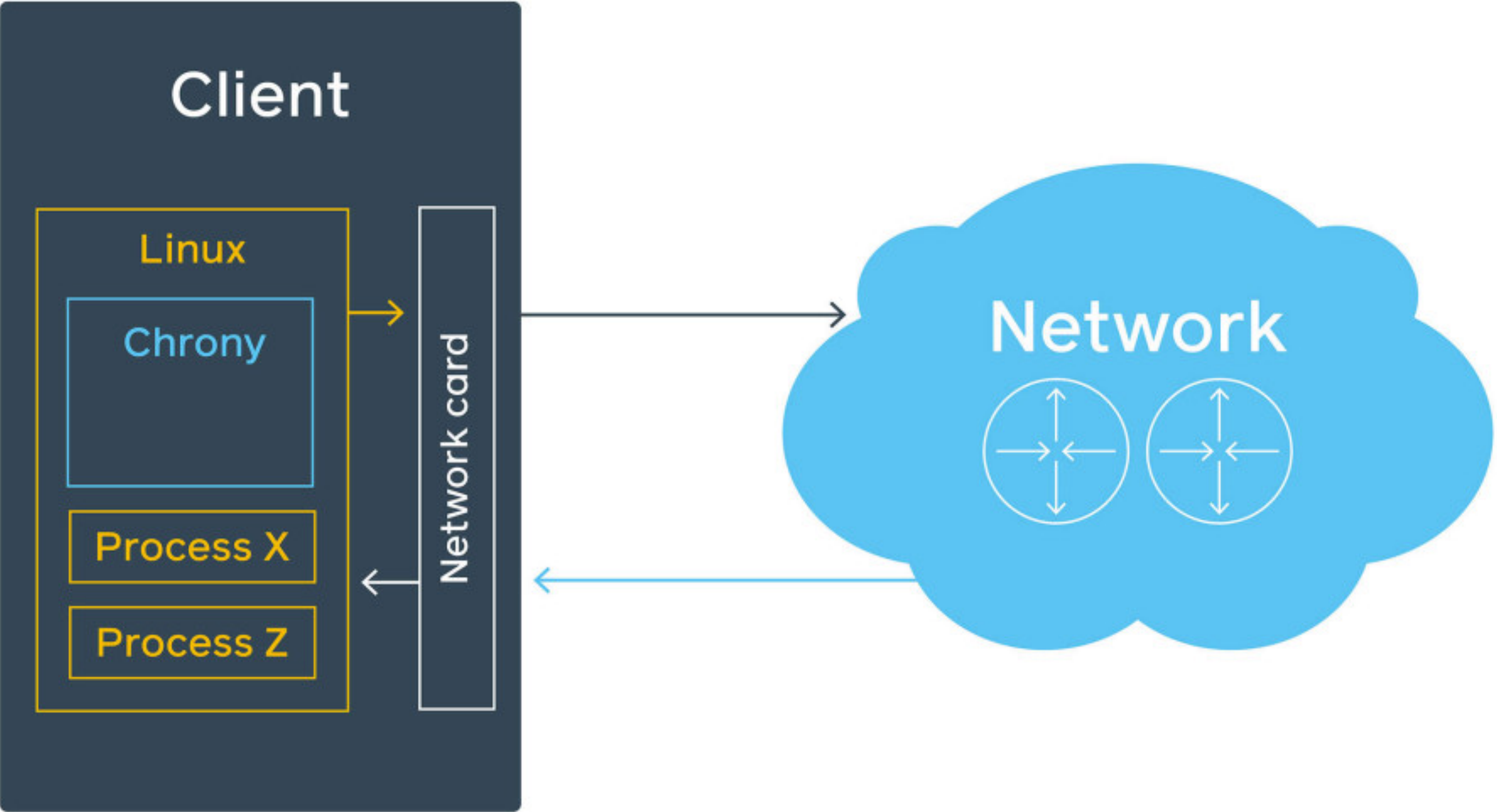

Validating improvements. Timestamps

```
1 | ethtool -T eth0
2 | Time stamping parameters for eth0:
3 | Capabilities:
4 |     hardware-transmit      (SOF_TIMESTAMPING_TX_HARDWARE)
5 |     hardware-receive       (SOF_TIMESTAMPING_RX_HARDWARE)
6 |     hardware-raw-clock     (SOF_TIMESTAMPING_RAW_HARDWARE)
```



Validating improvements. Dedicated testing device

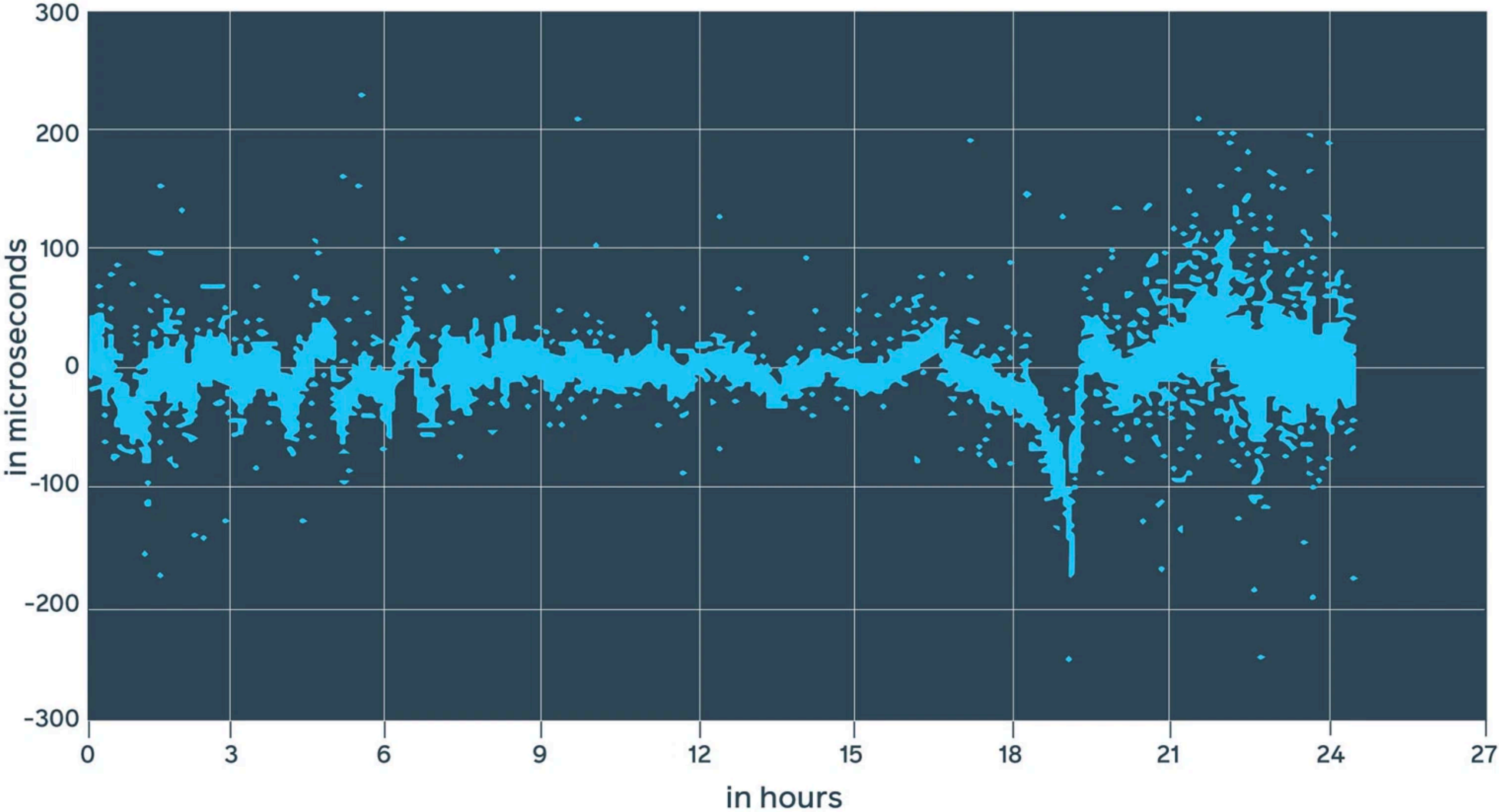

Validating improvements

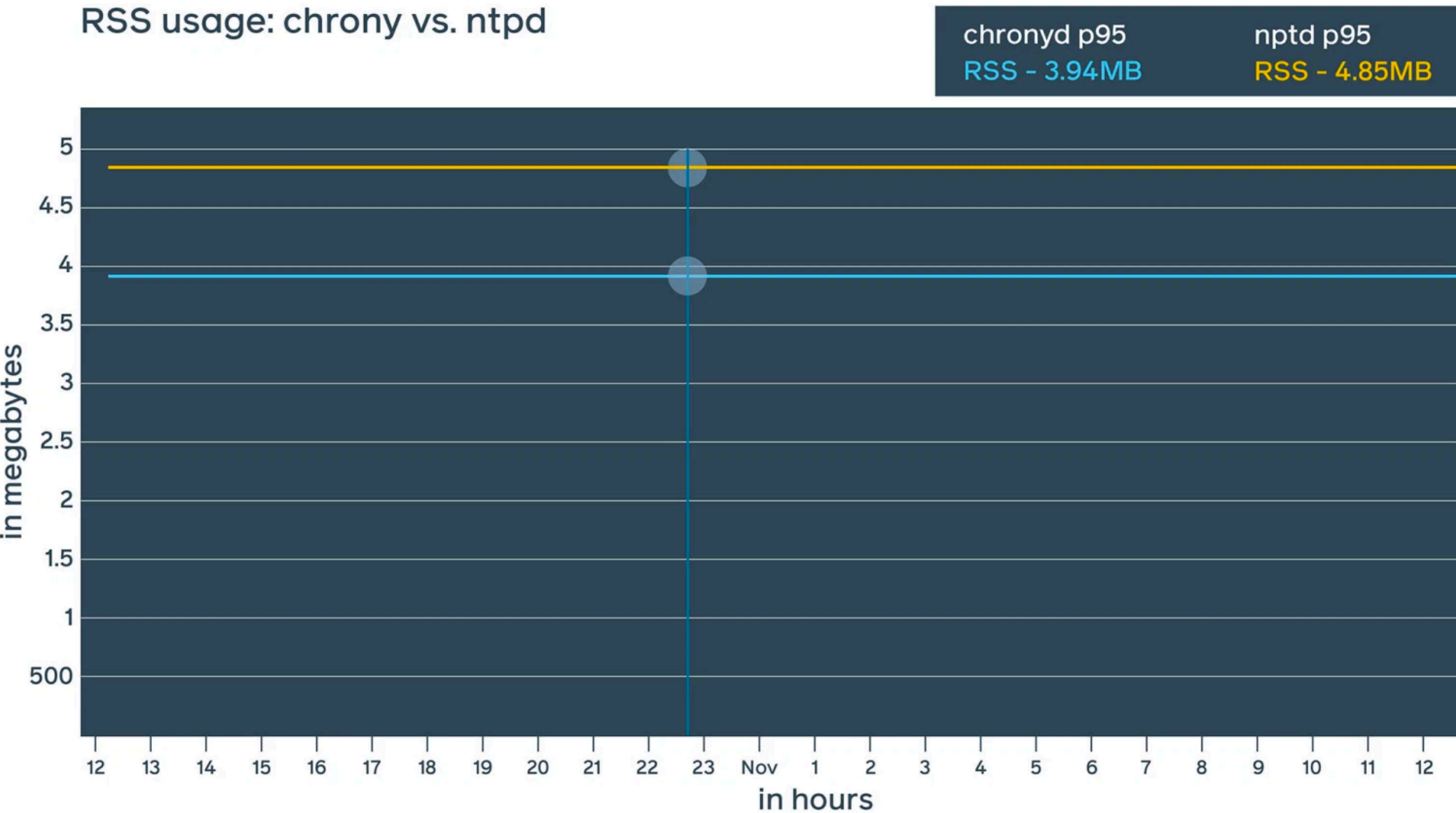
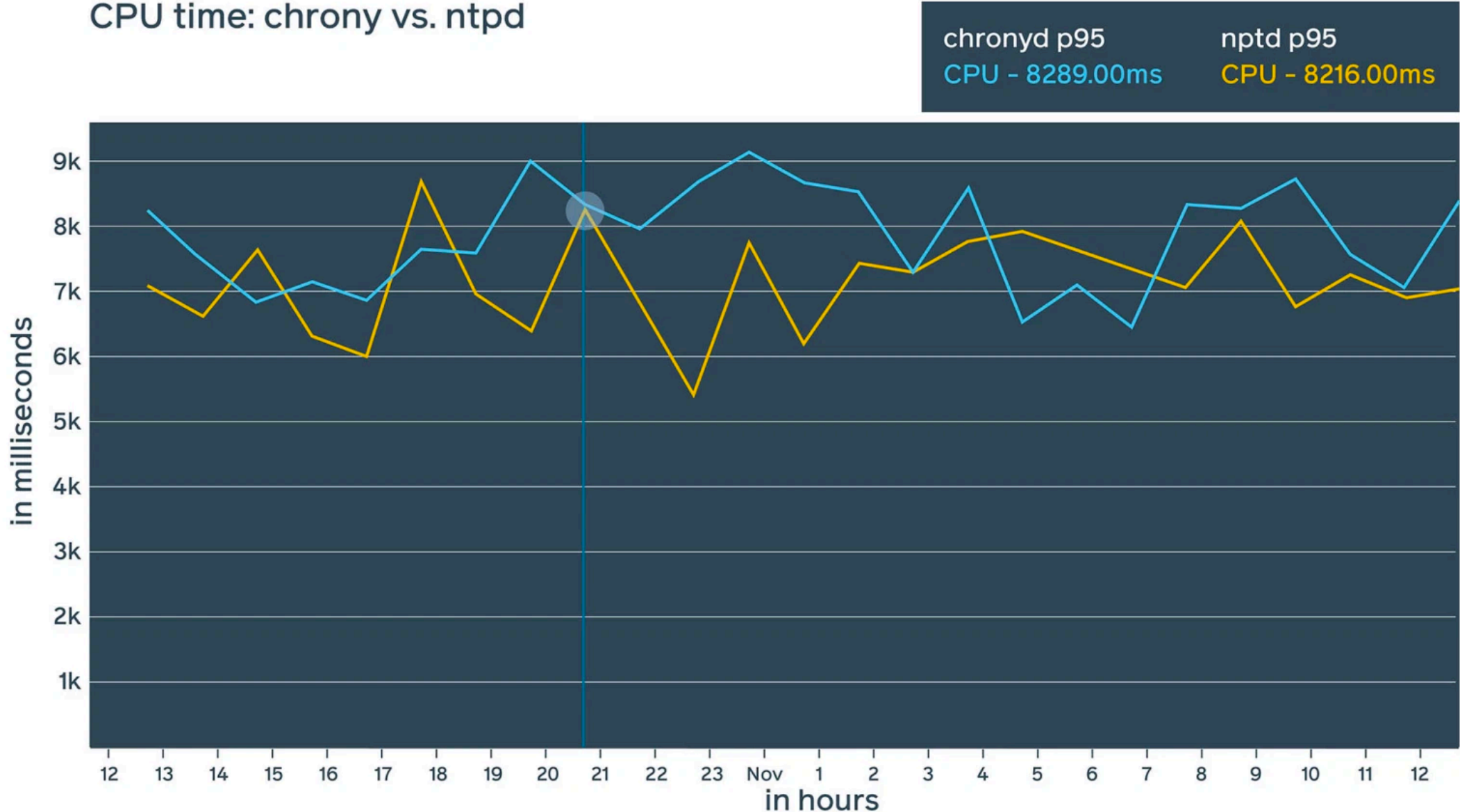

Public service



Public service



Public service

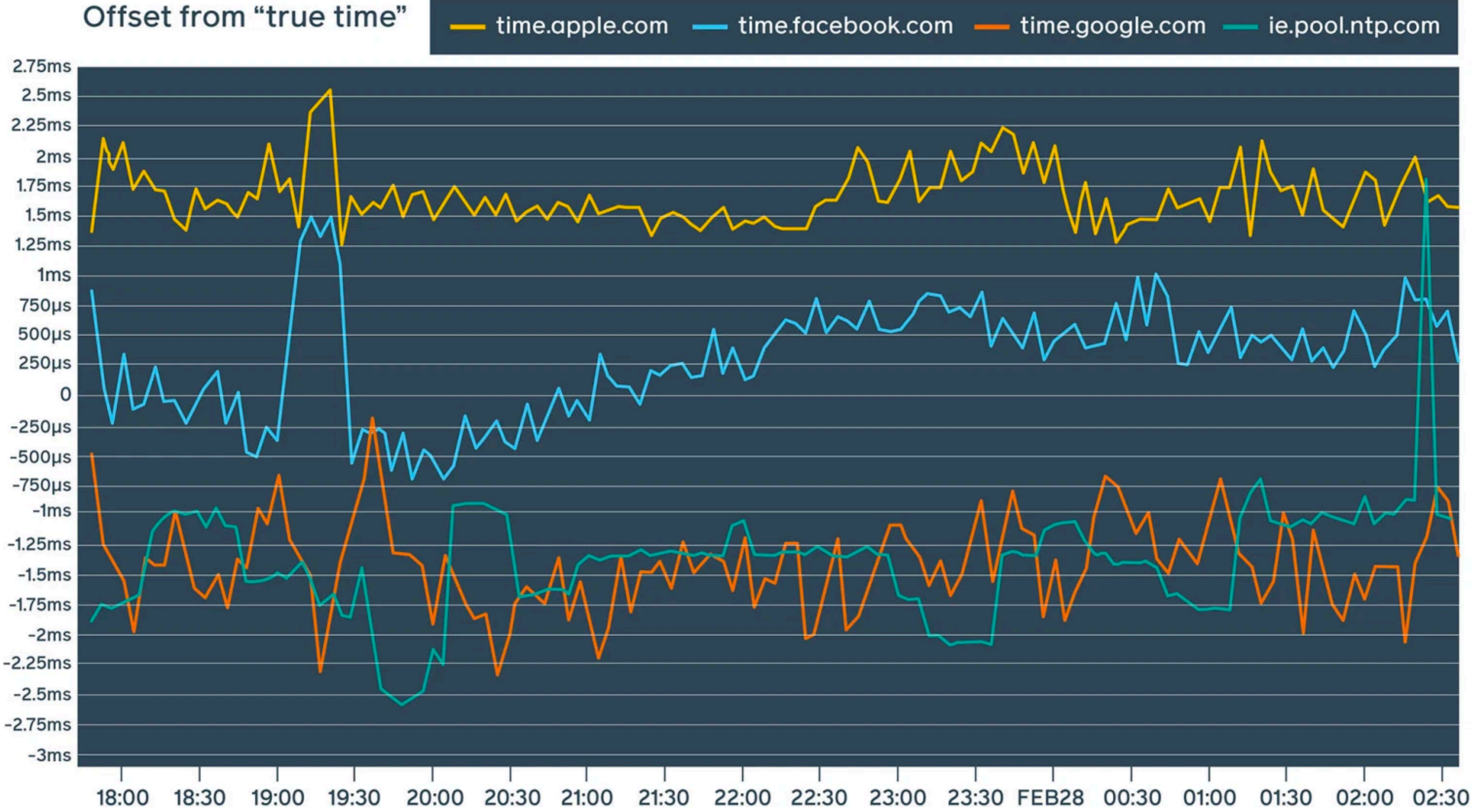

<https://engineering.fb.com/production-engineering/ntp-service/>



<https://github.com/facebookincubator/ntp>



What's next



PTP

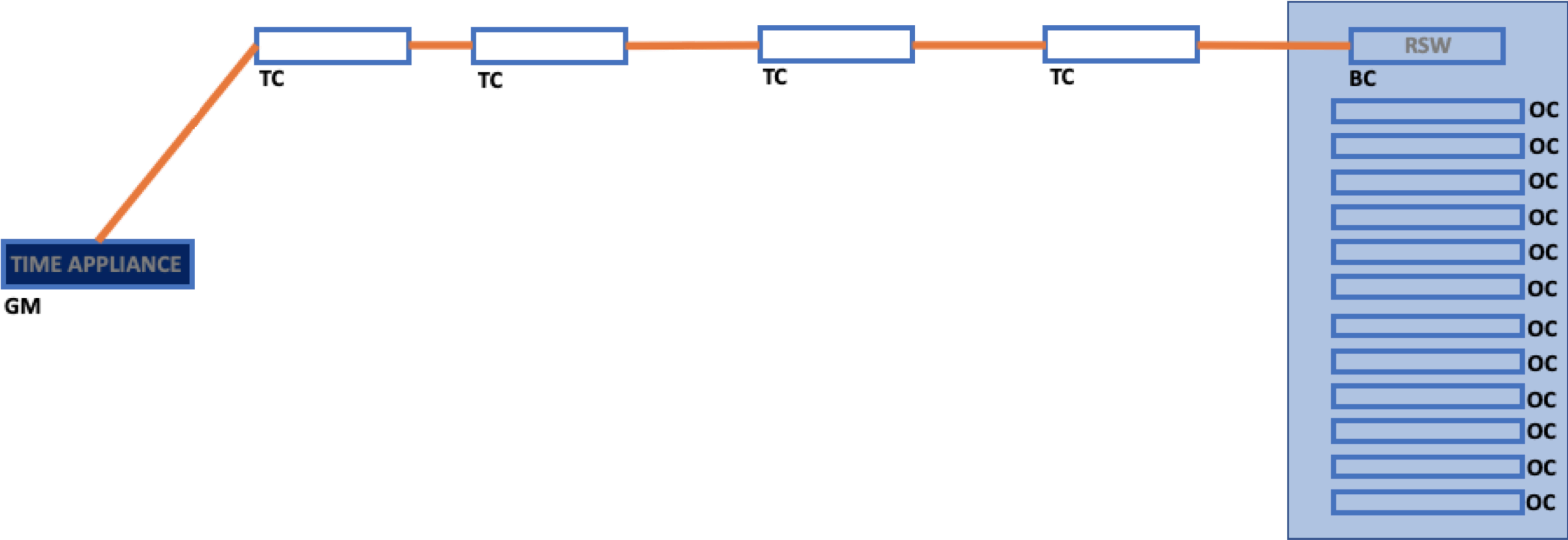

PTP

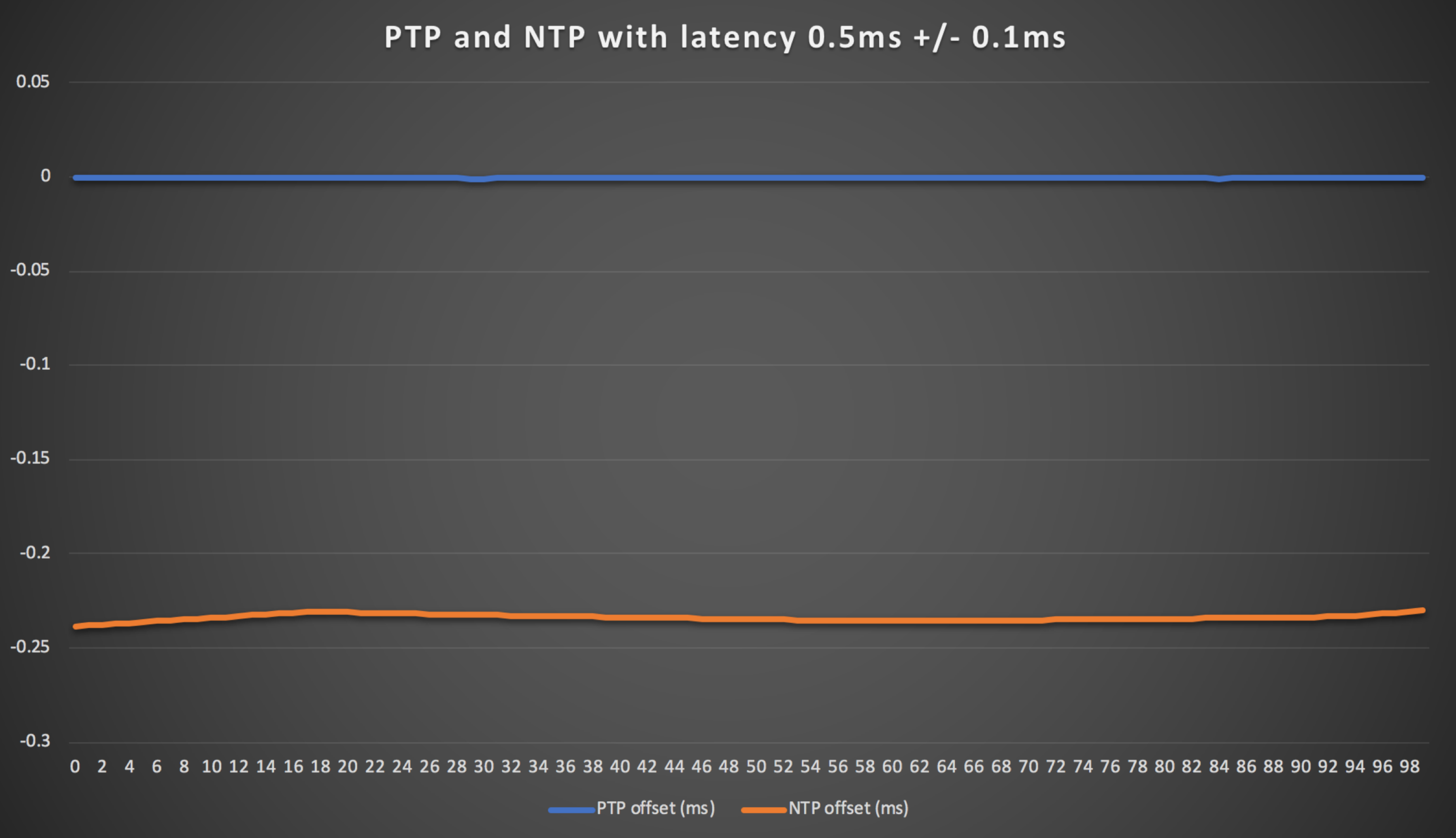

Open Compute Time Appliance Project

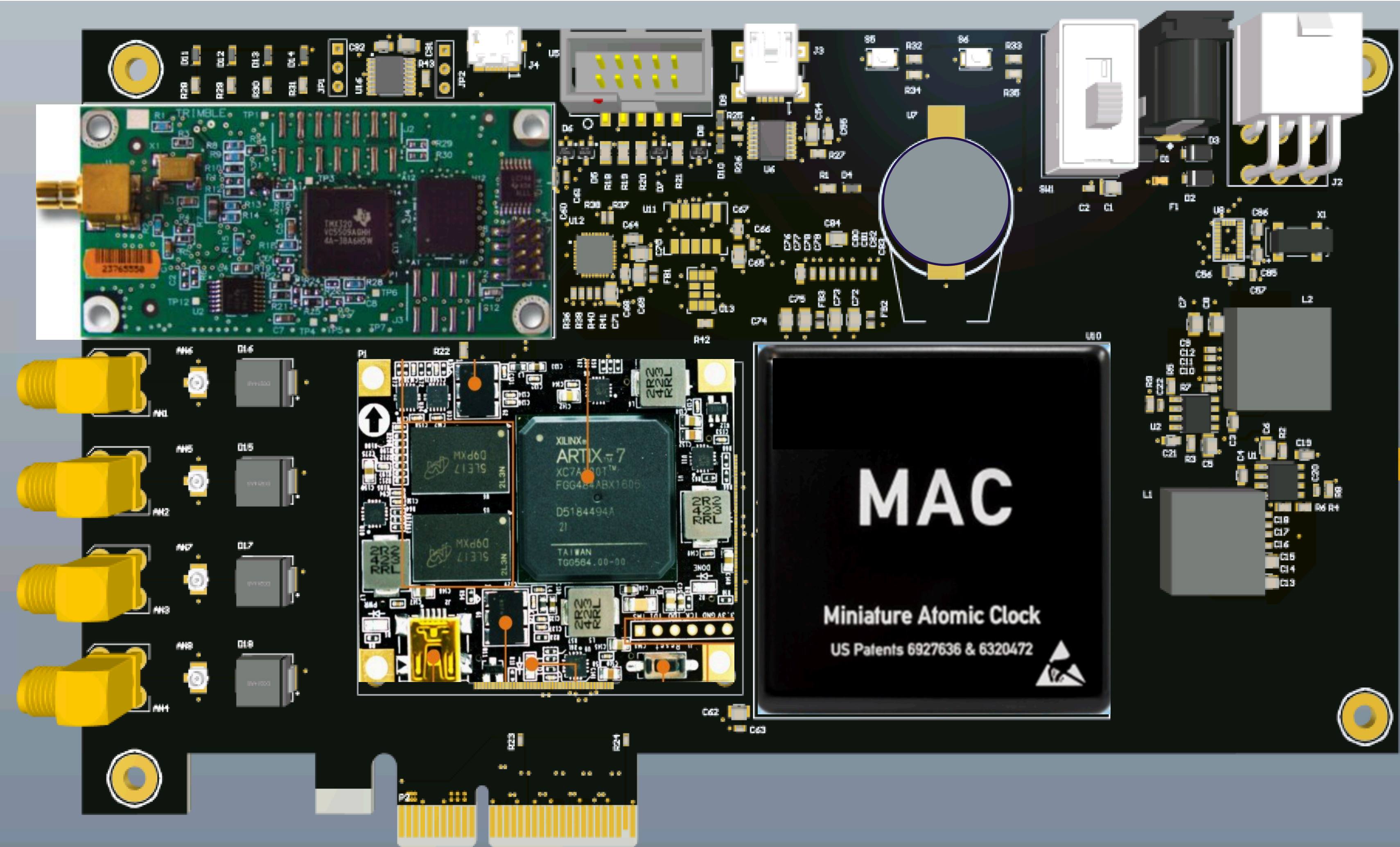

Thank you

